

矢視 A - A

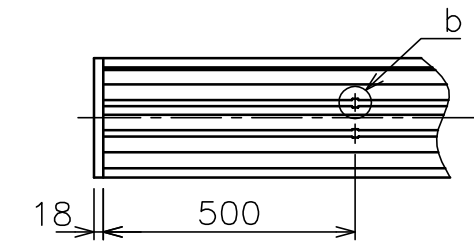

矢視 B

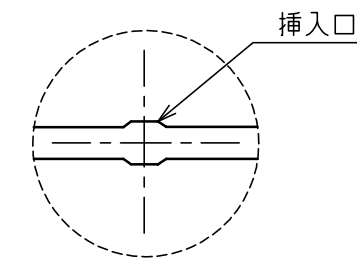
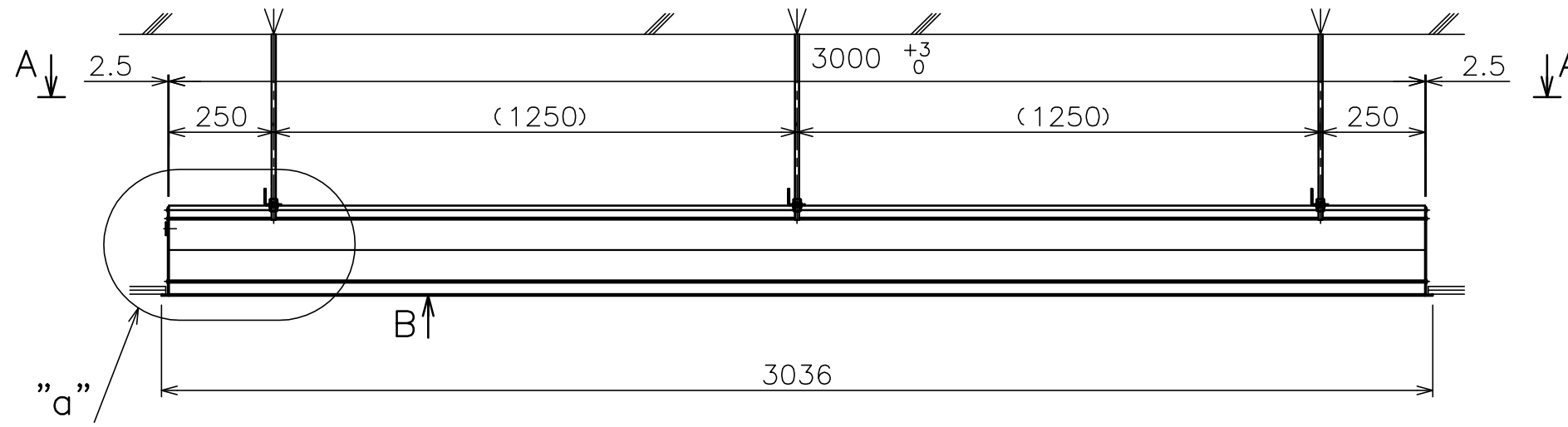

b部 M10ボルト挿入口拡大図

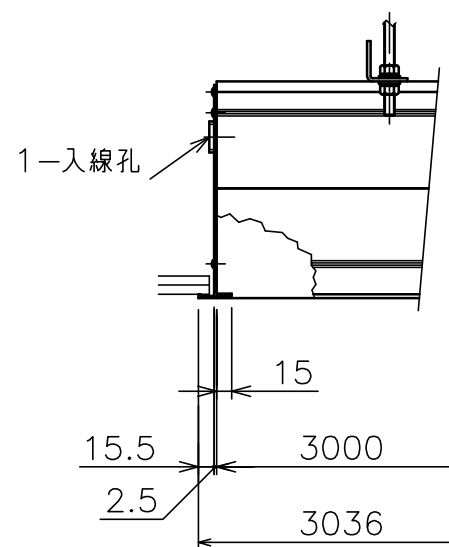

”a”部詳細

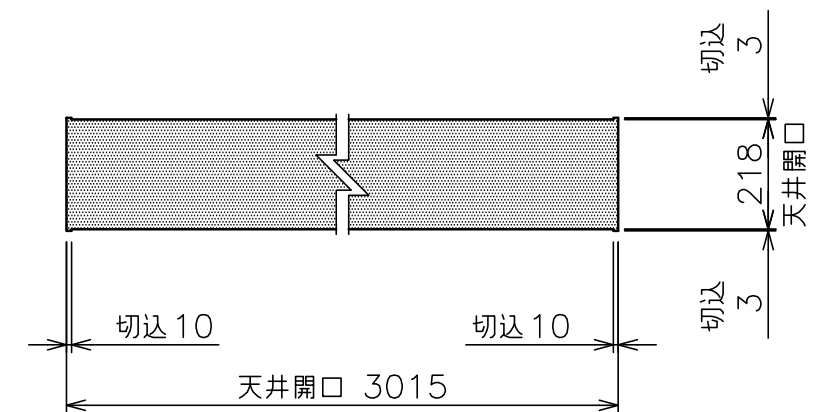
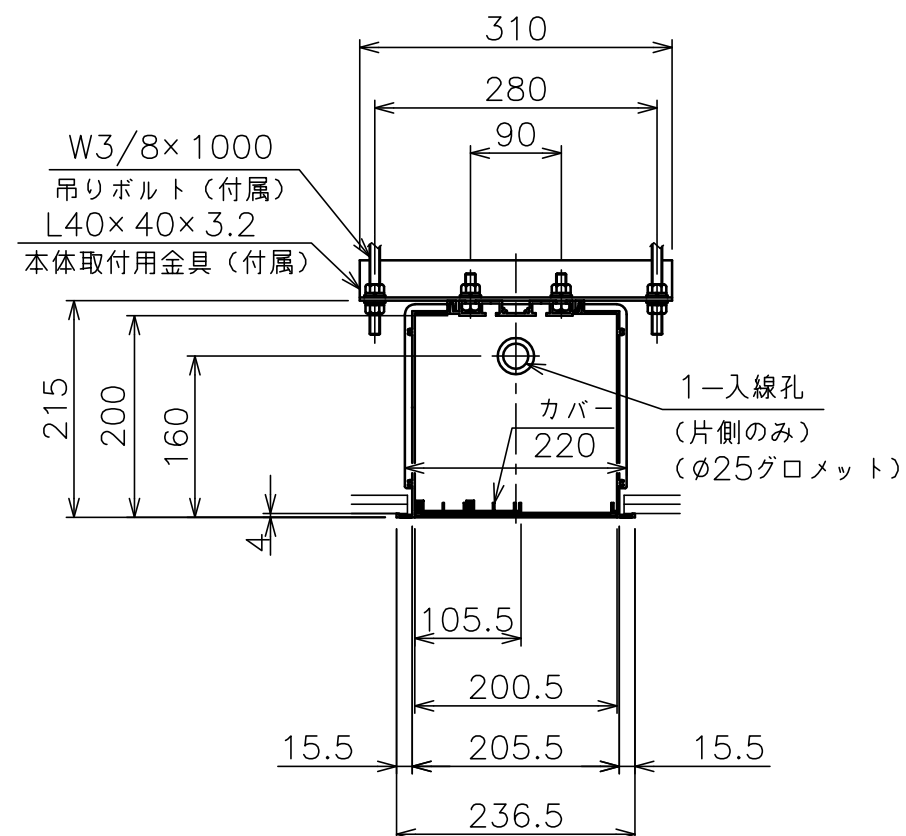

天井開口 KEYPLAN

| | |
|---------|-------------------------------------|
| 質 量 | 26.5kg |
| アルミボックス | A6063SS-T5 日塗IE27-90B相当シルキーホワイト色 |
| 備 考 | RoHS対応品 |