

矢視 A - A

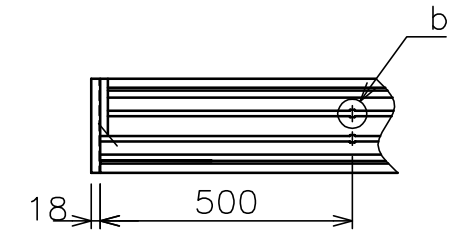

矢視 B

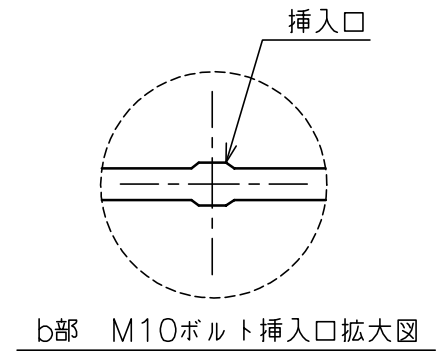
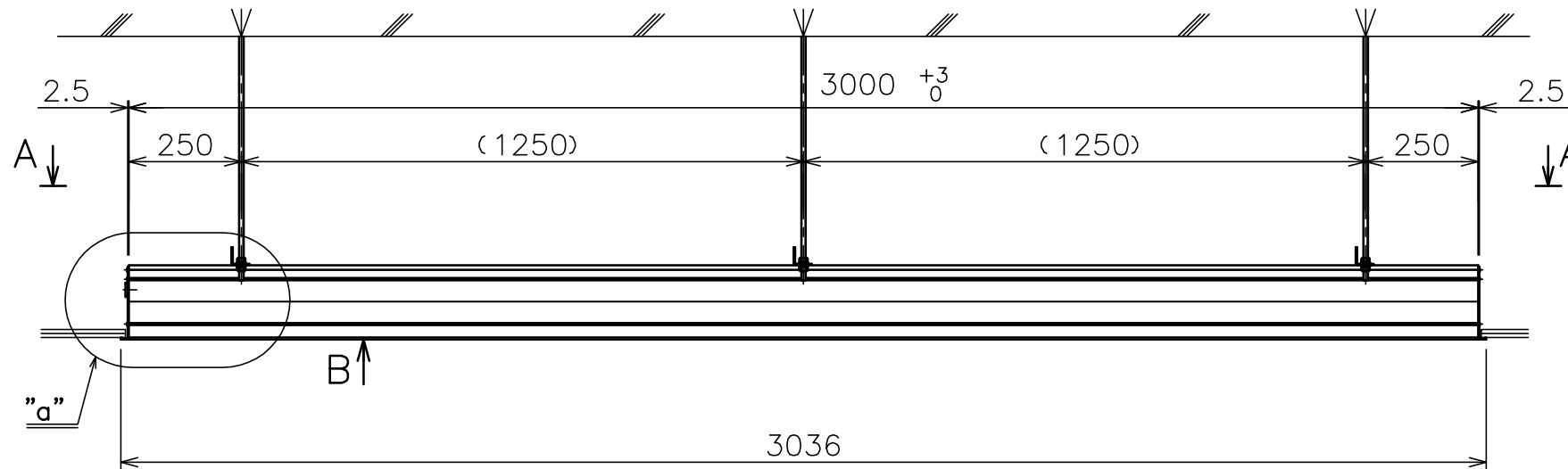

b部 M10ボルト挿入口拡大図

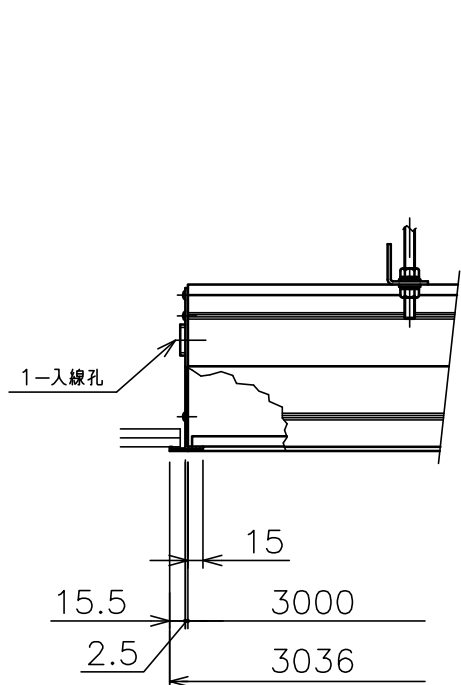

”a”部詳細

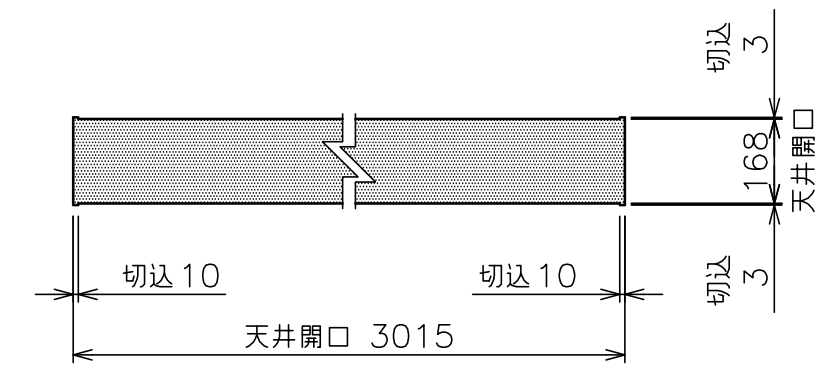
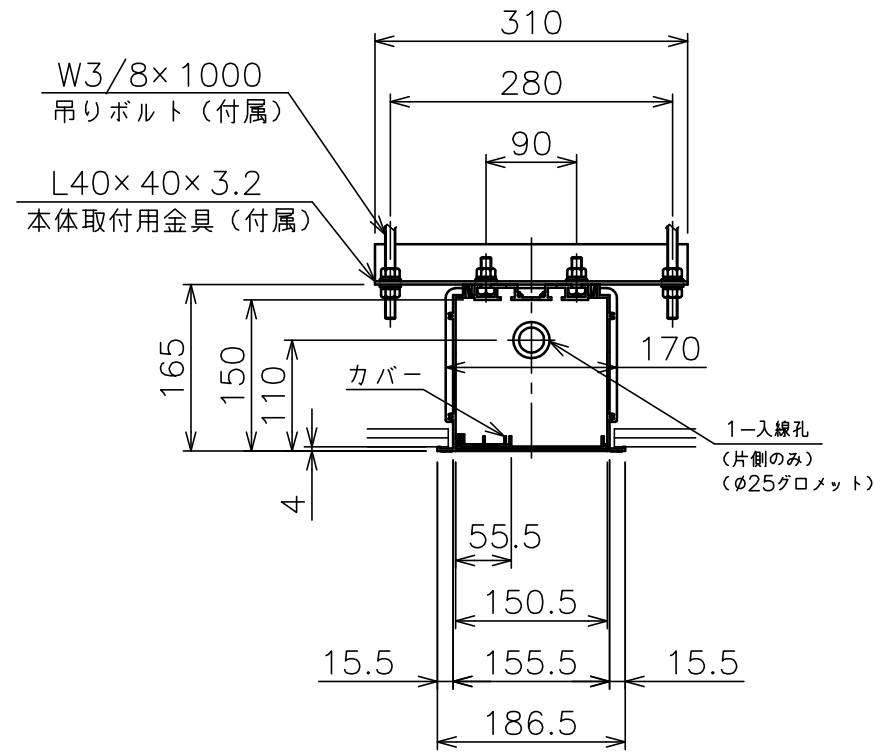

天井開口 KEYPLAN

質 量	21.5kg
アルミボックス	A6063SS-T5 日塗IE27-90B相当シルキーホワイト色
備 考	RoHS対応品